

Základní rozměry			Konstrukce	Materiál jazýčku	Označení	skladové číslo pro USA
Hřídel	Vrtání	Jmenovitá šířka těsnění				
d1		b				
mm			-	-	-	-
19,05	51,99	7,95	CRW1	R	7693	7693

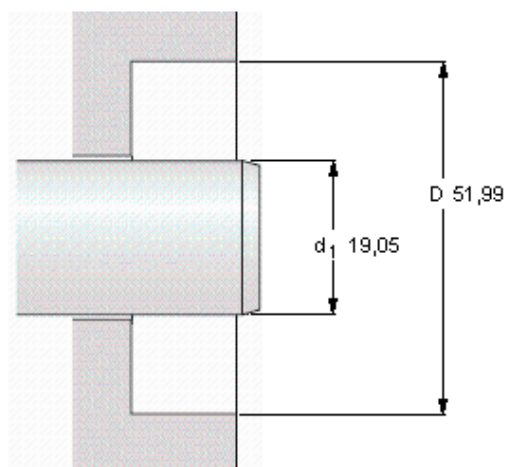

Permissible operating temperature [°C / °F]

min	max
-40 / -40	100 / 212
	short periods
	120 / 248

Rotational speed [r/min]

18046
at circumferential speed [m/s / ft/s]
18 / 59,04

Pressure differential [MPa / psi]

0,07 / 10,15

See also "Permissible speeds" and "Chemical and thermal resistance"